

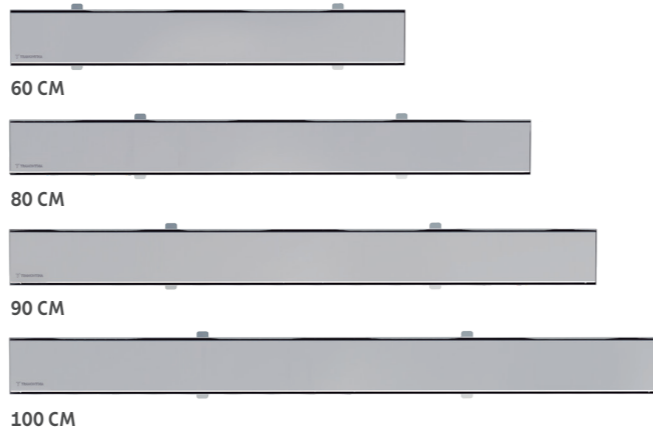

RALOS NEW SLIM

MODELO	REFERÊNCIA	DIMENSIONAL (AxBxC)
60 CM	94535/116	600 x 70 x 127 mm
80 CM	94535/118	800 x 70 x 127 mm
90 CM	94535/119	900 x 70 x 127 mm
100 CM	94535/120	1000 x 70 x 127 mm

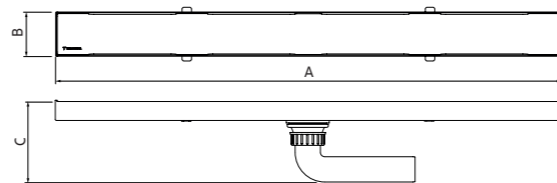

DIFERENCIAIS DO PRODUTO:

- RALOS EM AÇO INOX AISI 304
- VAZÃO DA ÁGUA: 44 L/MIN
- INCLUI VÁLVULA
- INCLUI JOELHO COM SAÍDA DE Ø 40 MM
- INCLUI GRADE RETENTORA

PARA AMBIENTES:



BANHEIRO



LAVANDERIA



ÁREA EXTERNA

TRAMONTINA

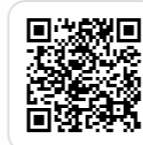

PLAYLIST
RALOS NEO



RALOS NEO

Nossos ralos foram desenvolvidos para garantir o **escoamento eficaz da água**, evitando acúmulos e oferecendo segurança contra alagamentos. Ideais para áreas internas e externas, **integram-se ao ambiente** de forma discreta e elegante — seja por meio do **acabamento em inox**, que traz durabilidade e fácil limpeza, **ou pelo sistema oculto**, que permite a integração com o ambiente.

94995/000





RALOS OCULTOS (PARA SEREM REVESTIDOS COM PORCELANATO)

MODELO	REFERÊNCIA	DIMENSIONAL (AxBxC)
NEO HIDDEN 10	94535/301	100 x 100 x 76 mm
NEO HIDDEN 15	94535/302	150 x 150 x 78 mm
NEO HIDDEN 7,5 x 70	94535/305	700 x 75 x 87 mm
NEO HIDDEN 7,5 x 80	94535/306	800 x 75 x 89 mm
NEO HIDDEN 7,5 x 120	94535/307	1200 x 75 x 96 mm

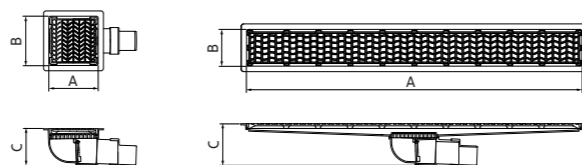

NEO HIDDEN 10



NEO HIDDEN 7,5 x 70

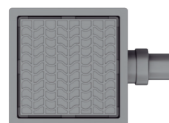

NEO HIDDEN 15



NEO HIDDEN 7,5 x 80



NEO HIDDEN 7,5 x 120

- Ralos em PVC com tampa oculta



RALOS COM TAMPA EM AÇO INOX

MODELO	REFERÊNCIA	DIMENSIONAL (AxBxC)
NEO SQUARE 10	94535/303	100 x 100 x 88 mm
NEO SQUARE 15	94535/304	150 x 150 x 90 mm
NEO SLIM 7,5 x 70	94535/308	700 x 75 x 99 mm
NEO SLIM 7,5 x 80	94535/309	800 x 75 x 101 mm
NEO SLIM 7,5 x 120	94535/310	1200 x 75 x 108 mm

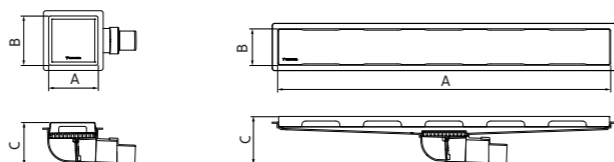

NEO SQUARE 10



NEO SLIM 7,5 x 70



NEO SQUARE 15



NEO SLIM 7,5 x 80



NEO SLIM 7,5 x 120

- Ralos em PVC com tampa em aço inox AISI 304
- Neo Square aço inox com espessura de 1,0 mm
- Neo Slim aço inox com espessura de 1,5 mm

PARA AMBIENTES:



BANHEIRO



LAVANDERIA



ÁREA EXTERNA

DIFERENCIAIS DO PRODUTO:

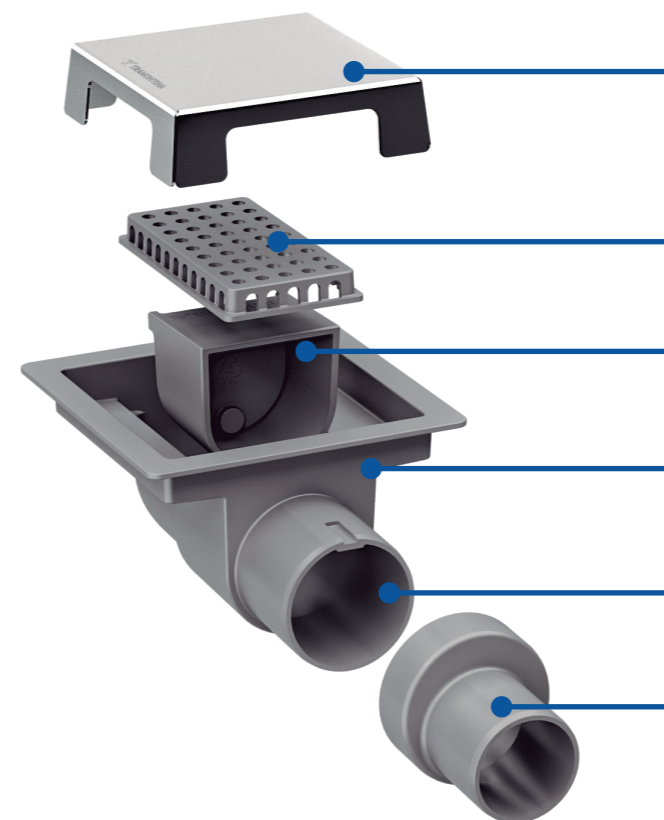

**TAMPA EM PVC (NEO HIDDEN)
OU EM AÇO INOX (NEO SQUARE/SLIM)**

Integram-se ao ambiente de forma discreta e elegante.

GRADE RETENTORA

Evita entupimentos e protege objetos de serem perdidos.

VÁLVULA AUTOMÁTICA ANTI-RETORNO

Impede a passagem de insetos.

BASE DO RALO

Ângulo de saída com acabamento polido para auxílio no escoamento.

SAÍDA DE Ø 50 mm

Permite a vazão máxima de 78 L/min.

BUCHA DE REDUÇÃO Ø 50/40 mm

Possibilita redução para tubos de Ø 40 mm.



VÁLVULA COM MAIOR VAZÃO

Evita transbordamentos, mesmo com o uso de chuveiros de alta vazão.
78 L/min. para saída de Ø 50 - 62 L/min. para saída de Ø 40

ENTENDA MELHOR ATRAVÉS DOS VÍDEOS:



ALTA VAZÃO
78 L/MIN.

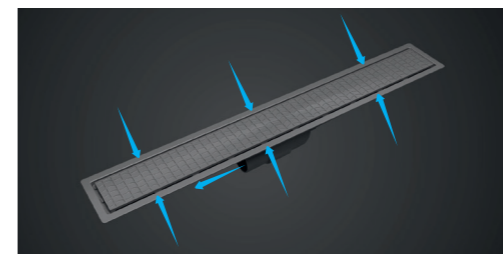

BUCHA DE
REDUÇÃO

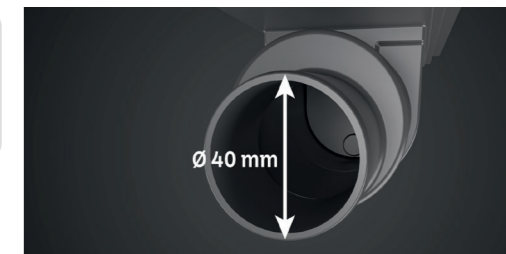

GRADE
RETENTORA

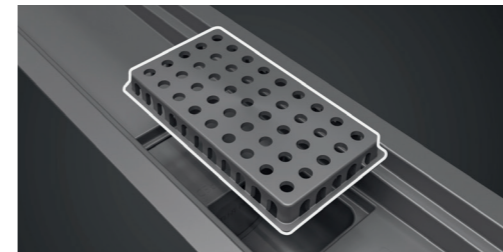

VÁLVULA
ANTI-RETORNO

