

**T**  
**TRAMONTINA**



**Ralos Neo**

# Ralos Ocultos

Neo Hidden 10

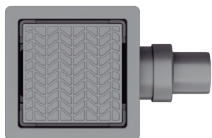

Neo Hidden 15

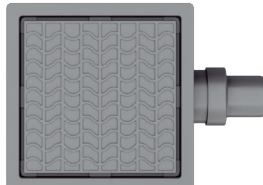

Neo Hidden 7,5 x 70

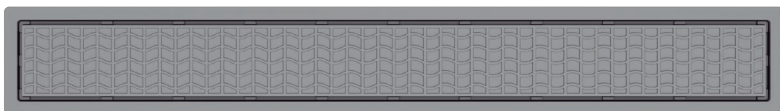

Neo Hidden 7,5 x 80

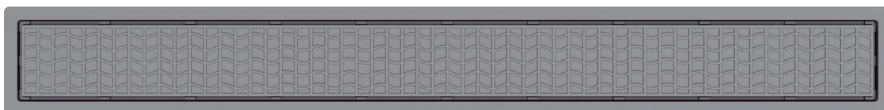

Neo Hidden 7,5 x 120

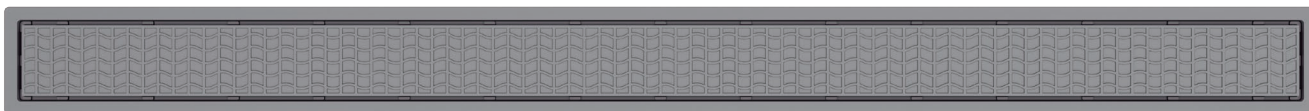

## Ralos Ocultos (para serem revestidos com porcelanato)

Ref.:	94535/301	94535/302	94535/305	94535/306	94535/307	
Nome:	Neo Hidden 10	Neo Hidden 15	Neo Hidden 7,5 x 70	Neo Hidden 7,5 x 80	Neo Hidden 7,5 x 120	
Dimensões	A	100	150	700	800	1200
	B	100	150	75	75	75
	C	76	78	87	89	96

### Informações técnicas:

Estrutura em PVC de alta resistência;

Abas que previnem infiltrações;

Válvula anti-retorno;

Grade retentora;

Bucha de redução 50/40 mm.

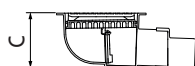
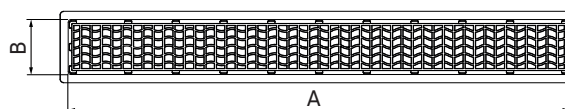
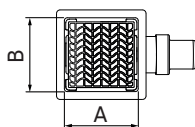

\*Somente compartilhe esse material com pessoas físicas se tiver a evidência do consentimento.

Produto para uso interno | Arquivos 3D disponíveis em: [global.tramontina.com/arquivos-bim](http://global.tramontina.com/arquivos-bim)

A Tramontina reserva-se o direito de modificar as informações da ficha técnica do produto sem aviso prévio. Todas as imagens são meramente ilustrativas.

Para mais informações acesse: [global.tramontina.com](http://global.tramontina.com)

# Tampa em Inox

Neo Square 10



Neo Square 15



Neo Slim 7,5 x 70



Neo Slim 7,5 x 80



Neo Slim 7,5 x 120

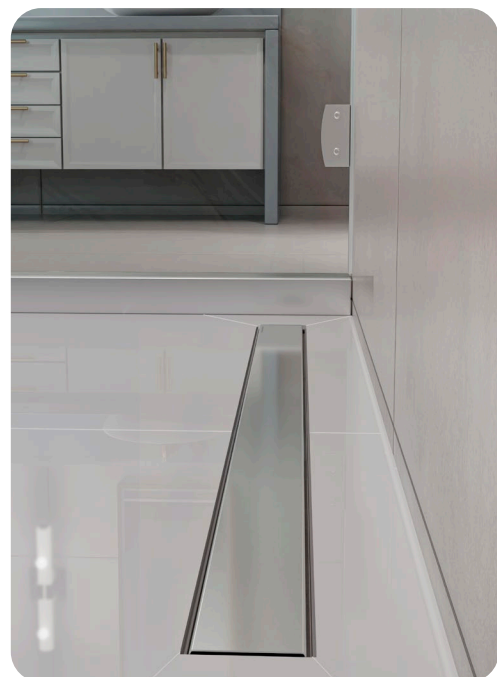

## Ralos com tampa em aço inox

Ref.:	94535/303	94535/304	94535/308	94535/309	94535/310
Nome:	<b>Neo Square 10</b>	<b>Neo Square 15</b>	<b>Neo Slim 7,5 x 70</b>	<b>Neo Slim 7,5 x 80</b>	<b>Neo Slim 7,5 x 120</b>
Dimensões	A	100	150	700	800
	B	100	150	75	75
	C	88	90	99	101

### Informações técnicas:

Estrutura em PVC de alta resistência;

Tampa em aço inox AISI 304

— Neo Square: 1,0 mm

— Neo Slim: 1,5 mm

Abas que previnem infiltrações;

Válvula anti-retorno;

Grade retentora;

Bucha de redução 50/40 mm.

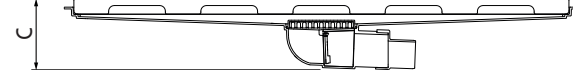
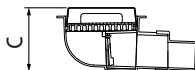
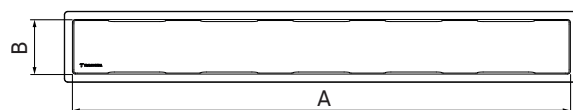
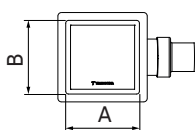

\*Somente compartilhe esse material com pessoas físicas se tiver a evidência do consentimento.

Produto para uso interno | Arquivos 3D disponíveis em: [global.tramontina.com/arquivos-bim](http://global.tramontina.com/arquivos-bim)

A Tramontina reserva-se o direito de modificar as informações da ficha técnica do produto sem aviso prévio. Todas as imagens são meramente ilustrativas.

Para mais informações acesse: [global.tramontina.com](http://global.tramontina.com)

## Modelo oculto

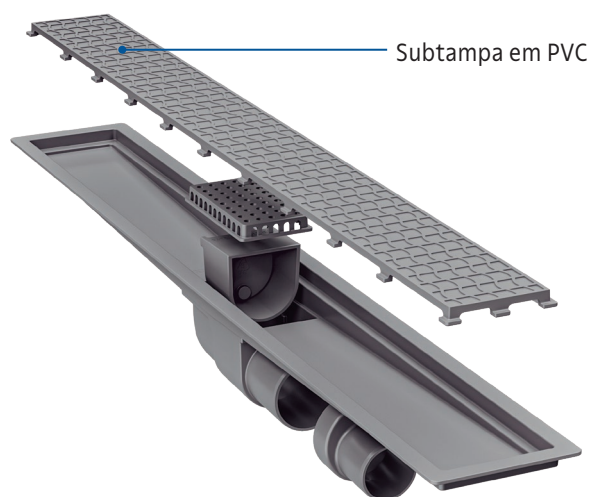

## Modelo com tampa em aço inox

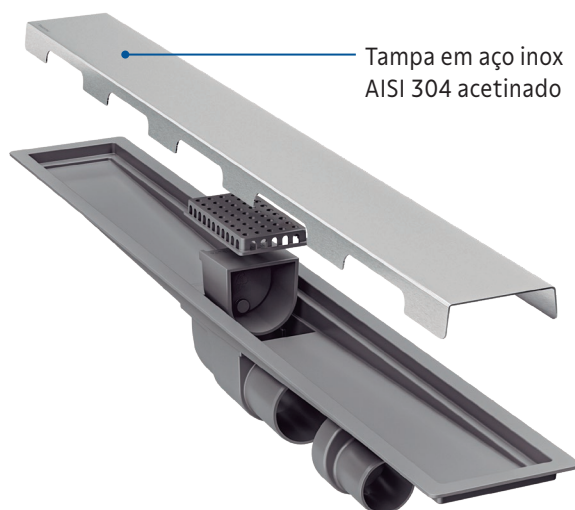

Grande retentora em PVC

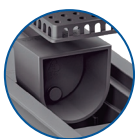

Válvula anti-retorno em PVC

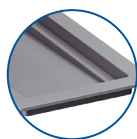

Base em PVC

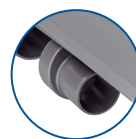

Bucha de redução 50/40 mm: Possibilita redução para tubos de  $\varnothing$  40 mm

### Válvula Anti-retorno

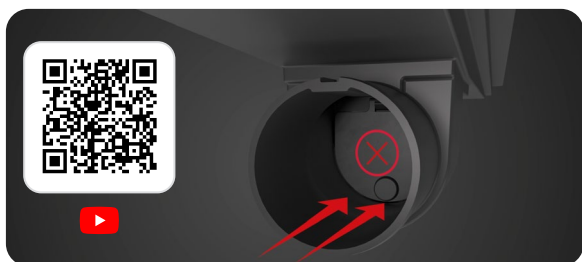

### Maior vazão

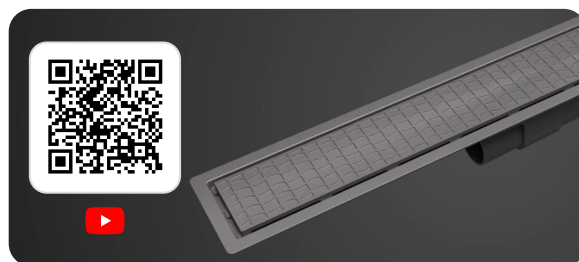

### Grade Retentora

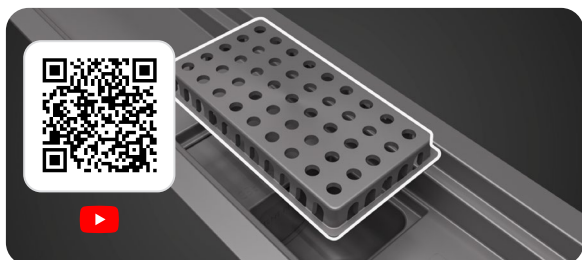

### Bucha de redução

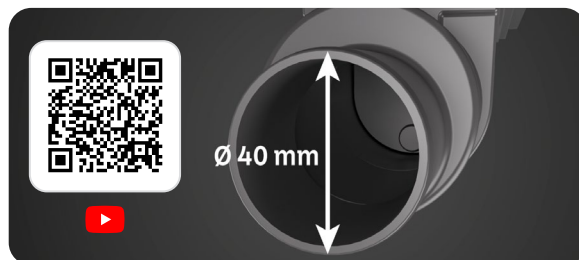

\*Somente compartilhe esse material com pessoas físicas se tiver a evidência do consentimento.

Produto para uso interno | Arquivos 3D disponíveis em: [global.tramontina.com/arquivos-bim](https://global.tramontina.com/arquivos-bim)

A Tramontina reserva-se o direito de modificar as informações da ficha técnica do produto sem aviso prévio. Todas as imagens são meramente ilustrativas.

Para mais informações acesse: [global.tramontina.com](https://global.tramontina.com)